

FABRICATION MANUAL PAINTED ACM

You discover why ALPOLIC® aluminum composite material (ACM) is the building material of the future as soon as you fabricate it. Our ACM is as easy to fabricate as wood. With the exception of ALPOLIC® Natural Metals (Titanium, Stainless Steel and Copper), no special tools are required. It can be curved, bent, routed, drilled, sawed, sheared, punched, trimmed and molded into complex shapes with conventional woodworking or metalworking tools. For ALPOLIC® Natural Metals, please contact your local representative for special fabrication requirements. ALPOLIC®'s versatility makes it readily adaptable to many other standard systems that are available from a variety of vendors, including rout & return systems, glazed-in systems and creative custom systems. In addition, you can create complex assemblies with ALPOLIC® in combination with polyethylene welding and support systems attached with structural adhesives. With the exception of ALPOLIC® Natural Metals (Titanium, Stainless Steel and Copper), ALPOLIC® surfaces can be connected to one another or to other materials by such conventional methods of attachments as rivets, bolts or screws.

For ALPOLIC® Natural Metals, please contact your local representative. For interior installations, you can easily attach flat surfaces of ALPOLIC® to such substrates as sheetrock and plasterboard with double-faced tape or a non-hardening adhesive. For further design, detailing and fabrication guidance, please refer to the materials in this section, or go to www.alpolic-usa.com. For samples or a list of authorized ALPOLIC® fabricators, please call the ALPOLIC® Hotline toll-free at 1-800-422-7270, or e-mail us at info@alpolic.com.

VISUAL CONSISTENCY

Each of our product types has special characteristics that can affect the visual consistency from lot to lot and even from panel to panel. It is important that these characteristics be considered when planning how to use and to install the ALPOLIC panels.

Solid Colors: Solid colors present the best case for panel to panel and lot to lot consistency. The industry standard for allowable variation is Delta E 1.0 or less in a hunter color space. Brighter colors, such as reds, yellows, blues, etc., which tend to be less opaque and which depend somewhat on film build (paint thickness) to achieve their appearance, will be more likely to exhibit more variation than subdued colors

Metallics, Pearlescents and Prismatic: The industry standard for color variation with metallic is Delta E 2.5 or less, much larger than the standard for solid colors. In coating the flakes will tend to align in one direction (flop). This greatly increases the directionality of the panel's appearance. For these reasons the panels must be installed with the directional arrows all aligned in the same direction and lots should not be mixed on a building face without first contacting MCFPA ALPOLIC for a confirmation that the lots are visually similar enough to be used together. The larger the flake size the greater the likelihood that the lots will not be able to be mixed.

Micas: The Mica finishes provide a metallic like appearance with a two pass paint system. Like the metallics the micas utilize flakes to give the flashy appearance, therefore, like the metallics, the mica finishes are directional and lots should not be mixed on a building face without first contacting MCFPA ALPOLIC for a confirmation that the lots are visually similar.

Note: All Color measurements are done using an R(0/45) geometry, D65 , 10 degree observer in a Hunter color space.

PROPERTIES

Thermal Expansion/Contraction

Thermal expansion/contraction must be considered when designing with ALPOLIC®.

To calculate thermal expansion/contraction, use the following equations:

$$\text{Thermal Expansion/Contraction (inches)} = 12 \times C_{th} \times \Delta T(^{\circ}\text{F}) \times L(\text{feet})$$

C_{th} = Coefficient of thermal expansion (13×10^{-6})

L = Length of ALPOLIC panel

$\Delta T = T_a - T_i$ where T_a is the actual temperature and T_i is the temperature when ALPOLIC was fabricated or installed. A positive ΔT indicates expansion and negative ΔT indicates contraction.

Thermal Expansion/Contraction Per Foot (inches)

ΔT	10	20	30	40	50	60
4,6mm	0.0016	0.0031	0.0047	0.0062	0.0078	0.0094
ΔT	70	80	90	100	110	120
4,6mm	0.0109	0.0125	0.0140	0.0156	0.0172	0.0187

Fire Resistance Properties

	ALPOLIC		ALPOLIC/fr	
	4mm/.157"	6mm/.236"	4mm/.157"	6mm/.236"
Surface burning ASTM E84				
Smoke developed index	0	10	10	0
Flame spread index	0	0	0	0
ASTM E108 (modified)				
Vertical transmission	Passed	Passed	Passed	
Ignition temp. ASTM D1929				
Flash ignition:	716°	716°	811°F	811°F
Self ignition:	752°	752°	837°F	837°F
Rate of burning ASTM D635	CC1	-	-	
ISMA test UBC 26-9	-	-	Passed	Passed
Potential heat release UBC 17-2	-	-	<6,000BTU/ft ²	
Combustion gas toxicity (U of Pitt)	-	-	No more toxic than wood	No more toxic than wood

Building Code Evaluations

ALPOLIC and A-LOOK	City of Los Angeles General Approval RR24932
ALPOLIC/fr	ICBO Evaluation Services, Inc. – Evaluation Report ER-4934 SBCCI PCT & ESI – Report No. 9816 BOCA Evaluation Services, Inc. – Research Report No. 97-17

Physical Properties: ALPOLIC

Item	Unit	ASTM	ALPOLIC	
			4mm	6mm
Specific gravity			1.38	1.23
Weight 1b/ft ²			1.12	1.50
Thermal expansion	10 ⁻⁶ /°F(-4-140°F)	D-696	13	13
Thermal conductivity	BTU/ft hr °F(apparent)	C-976	0.14	0.17
Thermal resistance	Ft·hr°F/BTU(apparent)	C-976	0.09	0.12
Deflection temperature	°F	D-648	232	231

Mechanical Properties: ALPOLIC

Item	Unit	ASTM	ALPOLIC	
			4mm	6mm
Tensile strength	PSI	E-8	6,900	4,900
Yield strength	PSI	E-8	6,400	4,400
Elongation	%	E-8	14	17
Modulus of bending elasticity (8" span)	10 ⁶ lb/in ²	E-8	6.2	4.7
Punching Shear Resistance				
Maximum load	Lb	D-732	1,920	2,120
Shear resistance (1"Ø)	PSI	D-732	4,000	2,800

Dent (Impact) Test by DuPont Method

Dent Depth (x10 ⁻² in) ALPOLIC			
Steel ball (lb)	Height (in)	4mm	6mm
0.66	2	0.59	0.47
0.66	12	2.01	1.38
1.10	20	5.28	3.50
2.20	12	6.18	4.25
2.20	20	8.43	6.42

Engineering Properties: ALPOLIC fr

Property	Unit	ALPOLIC/fr Total thickness		
		ASTM	4mm/.157"	6mm/.236"
Aluminum Thickness	in		0.020	0.020
Specific Gravity			1.90	1.81
Weight	lbs/ft ²		1.56	2.23
Coefficient of Expansion	in/in/°F	D-696	13x10 ⁻⁶	13x10 ⁻⁶
Tensile Yield Strength	psi	E-8	6344	3840
Tensile Strength	psi	E-8	7126	4266
Elongation	%	E-8	5.0	2.0
Flexural Elasticity	psi	C-393	5770x10 ³	4220x10 ³
Flexural Stiffness	psi	C-393	1.93x10 ⁹	4.98x10 ⁹
Punching Shear Resistance				
> Max. Load	lbs	D-732	2259	
> Shear Resistance	psi	D-732	4637	
Deflection Temperature	°F	D-648	241.8	228.8

Impact Resistance: ALPOLIC fr

		ALPOLIC/fr Dent depth (x10 ⁻² in)	
Steel Ball	Height	4mm/.157"	6mm/.236"
1.10 lb	20 in	5.07	3.93
2.20 lb	12 in	5.47	4.72
2.20 lb	20 in	7.40	6.30

Production Tolerance: ALPOLIC/ALPOLIC fr

Width	±0.08" (2mm)
Length	±0.16" (4mm)
Thickness	±0.008" (.2mm) ±0.012" (.3mm)
Bow	Maximum 0.5% of the length and/or width
Squareness	Maximum 0.2°

Body Integrity

			ALPOLIC	ALPOLIC	ALPOLIC/fr
Item	Unit	ASTM	4mm/.157"	6mm	4mm/.157"
Vertical pull	PSI	C-297	1,800	1,650	427
Drum peel	In-lb/in	D-1781-76	33.6	33.6	27.6
Nmm/mm	D-1781-76	150	150	123	110
Flatwise shear	PSI	C-273	1,220	1,195	949

Vibration Damping

As a laminated composite material, ALPOLIC® can dampen vibration by either absorbing vibration energy or converting it into thermal energy.

Vibration Damping (at 73.4°F)

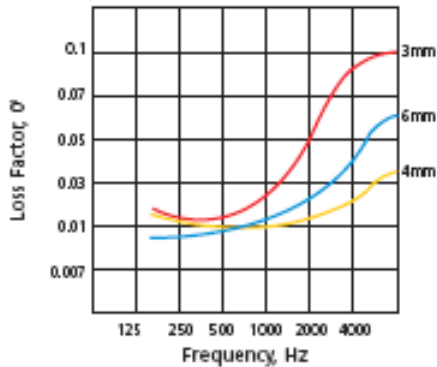

Sound Transmission

When tested in conformity with ASTM E-413, the following sound transmission classes (STC Nos.) were established:

4mm-STC 26

6mm-STC 26

Sound Transmission 4mm

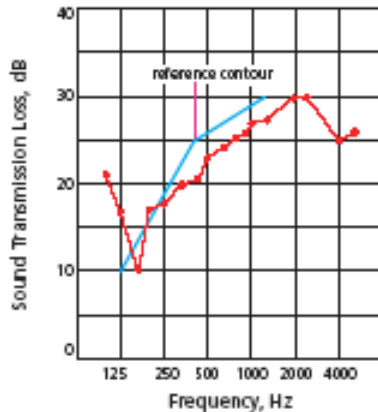

Sound Transmission 6mm

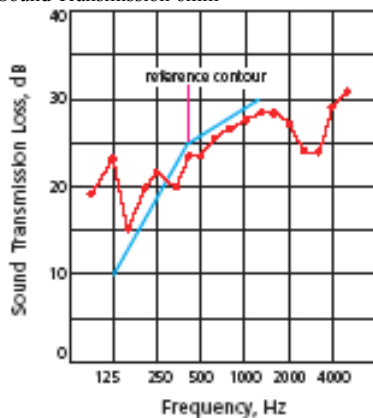

Wind Load Deflection

Wind load deflection depends on the thickness, aspect ratio, span and boundary condition (whether ALPOLIC® is simply supported or fixed).

The aspect ratio is the ratio of the longer to the shorter dimension of a panel. Panels with the same area but different aspect ratios will have different wind load deflections. For example, a 2' x 8' panel with an aspect ratio of 4 will have a smaller wind load deflection than that of a 4' x 4' panel with an aspect ratio of 1.

Wind Load Deflection: 4mm

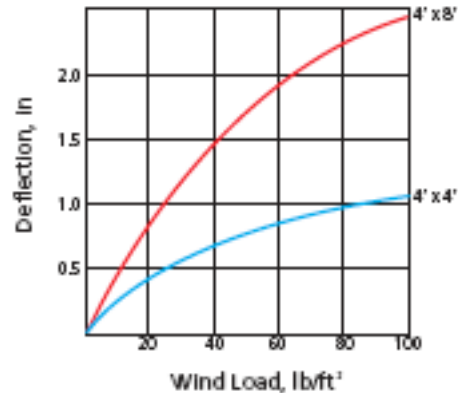

Wind Load Deflection: 6mm

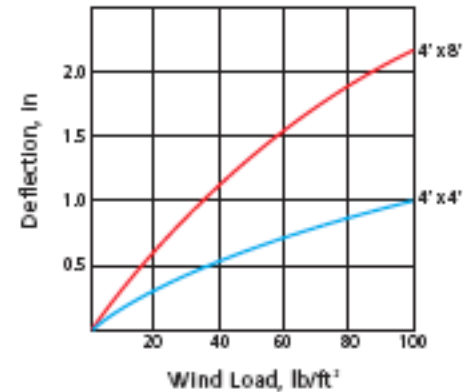

For more information and calculations for wind load and deflection please refer to the download section of ALPOLIC-USA.com

MECHANICAL PROCESSING

Cutting/Saw

ALPOLIC[®] can be easily cut using standard woodworking saws (i.e. circular hand saw or panel saw). A carbide tip blade made for aluminum and plastic is the most suitable for cutting ALPOLIC[®] (Refer to next page).

Cutting/Shear

Square shear cutting is the easiest method for cutting large panels. Some shear droop may result at the cut part of the aluminum surface material.

For shear cutting ALPOLIC[®]: recommended rake angle for shear cutting as listed below.

<i>Thickness of ALPOLIC[®]</i>	<i>Clearance</i>	<i>Rake angle</i>
3 mm	0.002"	1°
4 mm	0.002"	1° 30'
6 mm	0.008"	2° 30'

Edge Finishing

When a smooth finished edge is required on ALPOLIC[®], the following equipment can be used to provide the specific requirements: woodworking planer or shaper, tenoning machine or milling machine.

The edging process provides smooth, crisp, clean edges, to insure clean joint intersections or to create a detailed frame effect when angled.

Processing

Because of ALPOLIC[®]'s composite makeup, the following process is required to fabricate sharp angle bends. This requires routing or cutting either a 'V' or 'U' groove in the ALPOLIC[®], as shown, to provide the required bend.

Observe the following recommendations in 'U' or 'V' cut processing:

The 'U' or 'V' cut bottom should not reach to the back of the aluminum. Leave about 0.008 - 0.016" of polyethylene core.

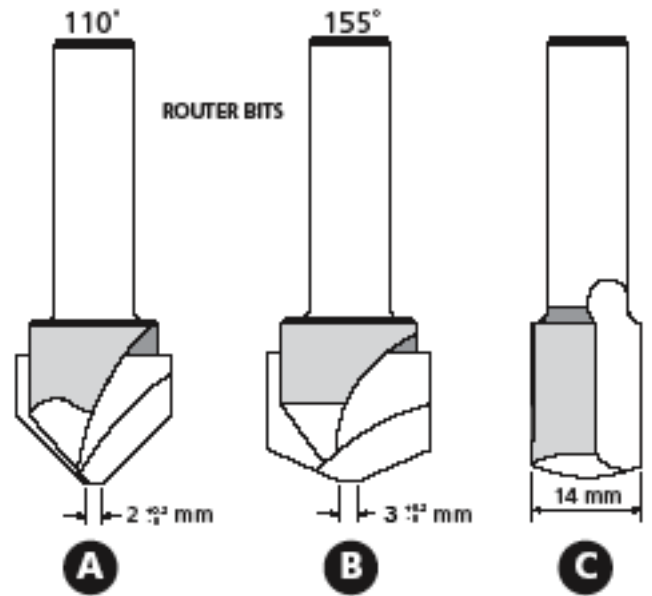
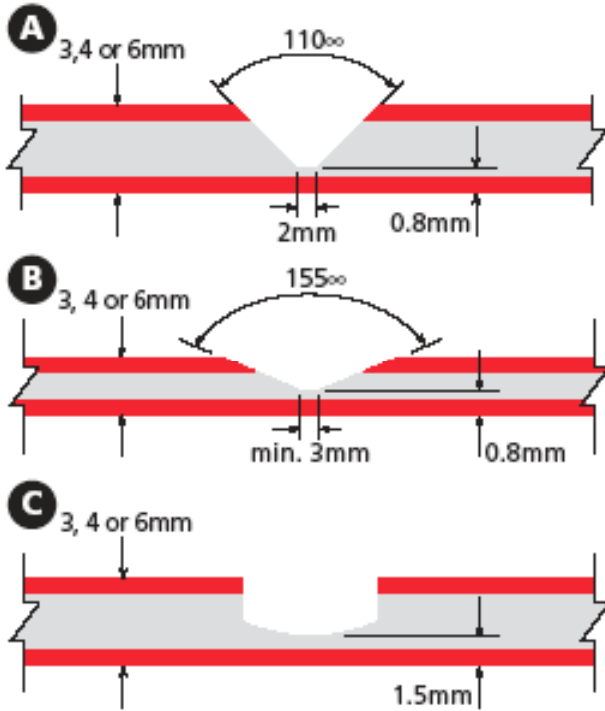

Router and Trimmer Tools

Use the bit as shown in the drawings below, which corresponds to the cut diagrams above.

Number of teeth	2 - 4
Rotation speed	20,000 - 30,000 rpm
Feeding speed	10 - 16 ft/min.
Material	Carbide

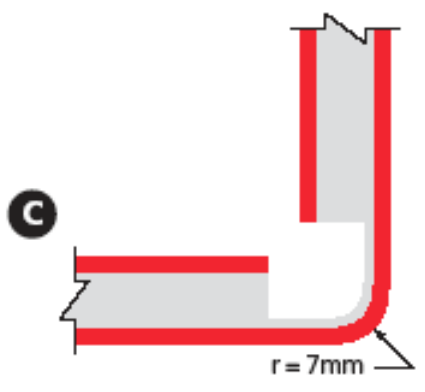
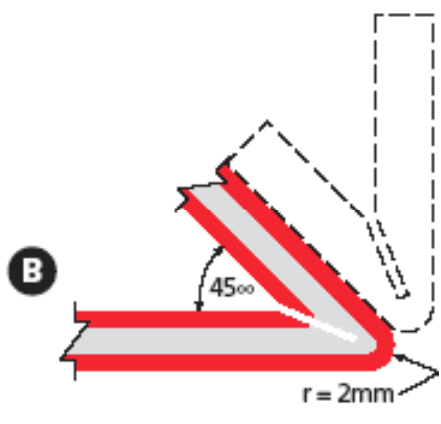
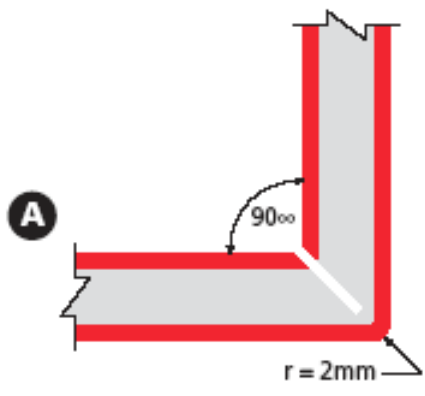

Curving

ALPOLIC[®] can be easily curved using any of the following processes: Press Break, Roll Bender, or Pipe Fixture.

The following are guidelines and limitations for curving ALPOLIC[®] panels.

NOTES:

Press Brake

The minimum bending radius using a press brake is shown in the following table.

The Minimum Bending Radius with a Press Brake, 90° Bending and Internal Radius

<i>Thickness of ALPOLIC</i>	<i>Traverse (width)</i>	<i>Parallel (Length)</i>
3 mm	1 1/2"	2"
4 mm	1 1/2"	2"
6 mm	2"	3"

Guidelines in bending process:

Because the aluminum surface material can be easily scratched, it is recommended that the following precautions be taken:

- a) To prevent scratches, a protective pad should be used on the die of the press brake.
- b) Pay attention to any scratches on the punch. It is recommended to use a fully polished punch.
- c) To prevent scratching, it is best to leave the factory applied protective film on the ALPOLIC[®] during processing. Be sure there are no air bubbles or wrinkles before processing.
- d) With ALPOLIC[®], the volume of spring back varies somewhat in relationship to the bending direction, thickness, material temperature and the radius of the required bending angle.

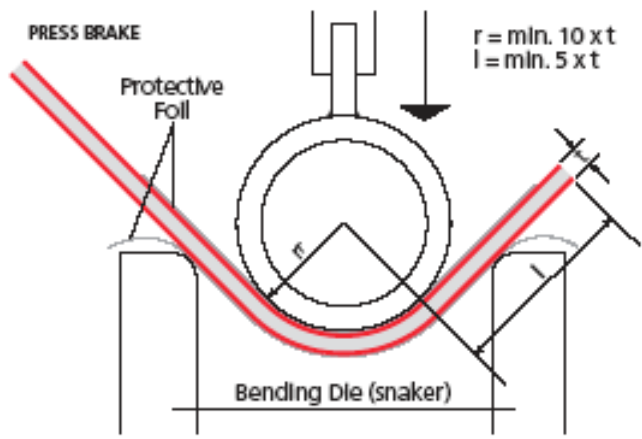

Bending with a Roller Bender:

A Roller Bender enables a larger bending radius than a press brake. The bending angle is determined by the diameter of the roll and the distance between the rolls. However a flat surface will appear at the beginning and the end of the panel. When this is not acceptable, it will be necessary to cut off and remove the flat surface in the finish fabrication process.

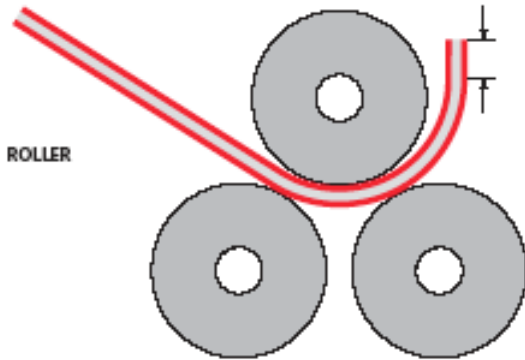

Bending with Clamped Pipe Fixture:

ALPOLIC® can be bent over a pipe of the proper inside diameter that is securely clamped to a table. A hinged leaf attached to the end of the table will make bending easier. Initial bending beyond 90 may be required to compensate for any memory spring back.

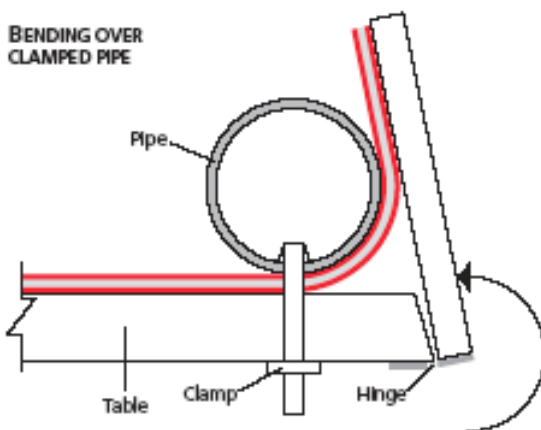

Punching/Drilling

Punching

Punching with a press sometimes causes shear droop in the aluminum surface material similar to shear cutting. It is preferable that the clearance of punch and die be made as small as possible (thickness of panel times 5%).

In the case of a small diameter hole (under 1/6") the tool may need to be modified as shown below to ensure that the polyethylene is completely removed in the process.

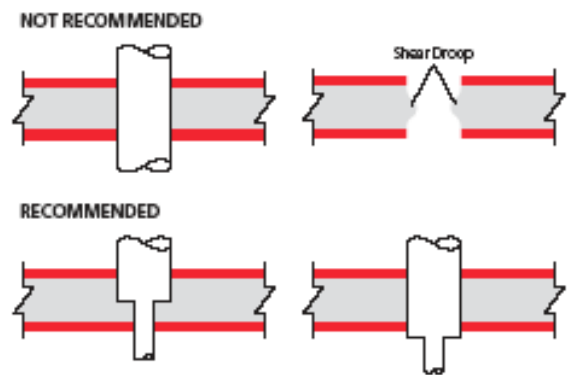

Drilling

ALPOLIC® can be drilled with standard twist drills used for aluminum and plastics.

WORKING SPECIFICATIONS:

- Drill bit: Twist drill, high speed steel.
- Tip Angle: 100-140 degrees, or counter-bore grind with centering tip.
- Cutting speed: 164 RPM to 984 RPM.

Quick removal of chips can be achieved by a high RPM, slow feed speed and occasional lifting of the bit.

Attachment Systems

Attachment Concepts

Please reference the joint details diagrams in the download section on ALPOLIC-USA.com

JOINING ADHESION

Typical methods of joining ALPOLIC® are the use of threaded fasteners, rivets, adhesives and double-faced high strength tapes. Proper consideration should be given to the thermal expansion characteristics of ALPOLIC®. (See page 22)

Use the general guidelines listed below when other elements come in direct contact with the surface of ALPOLIC®. When attaching copper, iron, brass, raw steel and bronze consideration needs to be given to the possible corrosion of joining surface due to electrolysis of dissimilar materials. If these materials must be used, make sure that a protective coating or separation exists between the two surfaces.

Threaded Fasteners

When using threaded fasteners, caution should be taken not to over tighten the fastener. The examples below show different threaded fastening methods.

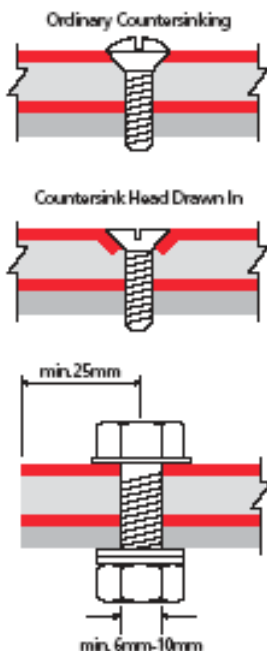

Rivets

Rivets can be used to fasten ALPOLIC® panels together or to aluminum extrusion profiles. Rivets are especially suitable for fastening when vibration is likely. Colored plastic concealment caps can be used to conceal exposed rivet heads.

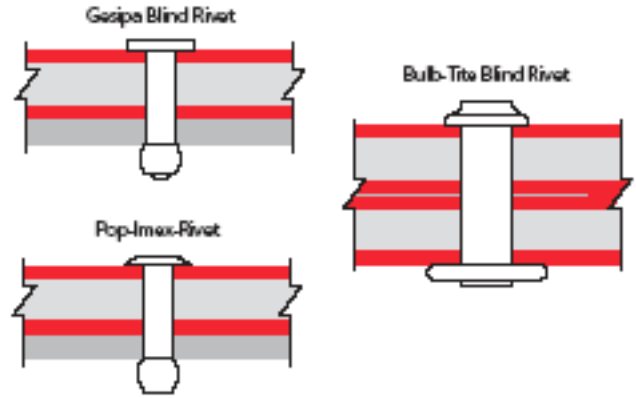

Adhesives & High Bond Tapes

When the ALPOLIC® attachment surface is flat (i.e. wall, ceiling, sign board, etc.) construction adhesive or double-faced high bond tapes can be used for installation. See the technical bulletin on ALPOLIC and VHB tapes in the download section of ALPOLIC-USA.com. See recommended adhesive supplier for more details.

Adhesives for ALPOLIC®

Adhesives suitable for adhering ALPOLIC® to various kinds of substrates are shown in the following table.

Kind of Adhesives	Substrate				
	A	B	C	D	E
Epoxy-based	•	•	•	•	•
Acrylate-based	•	•	•		•
Chloroprene-based	•		•		•
Nitrile rubber-based	•		•		•
a-cyano acrylate-based					

Welding/Hot Melt

Hot Air Welding

This process is used to join ALPOLIC® panels through a process of welding the polyethylene core.

Edge Preparation

ALPOLIC® parts should have edges beveled to the corresponding angle of the finished part and allowing an exposed surface on the welded side. A low-density polyethylene rod should be used in conjunction with a high-speed hot air welder equipped with a pressing apparatus.

WELDING SPECIFICATIONS	
Welding Temperature:	446 - 464° F
Air Pressure:	0.10-0.14 lb/in
Pressing Pressure:	2.2-3.3lbs.
Welding speed:	40 in/min.

Conditions for Hot Air Welding

Welding Temperature	446 - 464° F
Pressure of air compressor	0.10 - 0.14 lb/in ²
Pressing pressure	2.2 - 3.3lb
Welding speed	40 in/min.

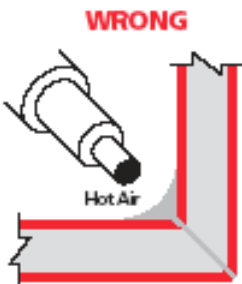
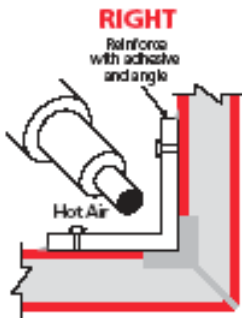

Hot Melt

When using Hot Melt systems to bond ALPOLIC®, be sure that the surfaces to be bonded have been abraded and cleaned.

Hot Melt adhesives designed for bonding aluminum or metals are recommended. To insure the maximum bonding, please consult the adhesive manufacturer.

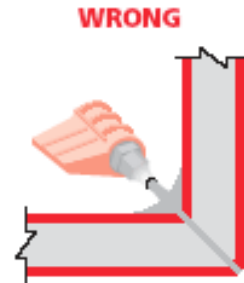
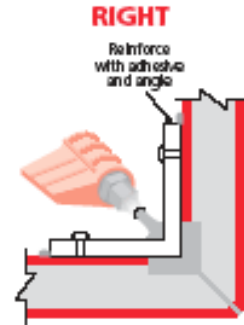

APPENDICES

Off-line Coating

ALPOLIC[®] can be off-line coated, if necessary. It is advisable to follow instructions as specified by the manufacturer of any paints to be used.

For off-line coating observe the following guidelines:

- Surface should be lightly abraded to provide a better coating surface. Surface should then be cleaned of all contaminants i.e. dust, dirt and oil etc. A soft cloth with a non-petroleum based solvent (e.g. rubbing alcohol) should be used to clean the surface area.
- Curing should be done at room temperature since temperatures above 175°F can cause deformation of the ALPOLIC[®] panel.

Screen Printing

Printing can be done on ALPOLIC[®] with an epoxy base or urethane base two-part type ink/paint.

In printing, use polyester-coated or anodize-finished ALPOLIC[®].

When selecting an ink, confirm its weatherability and adhesion with the ink manufacturer. It is recommended to test the ink's adhesion on the surface of the ALPOLIC[®] before production.

(For printing on ALPOLIC[®], observe the following guidelines)

- Remove all dust and dirt on the surface of ALPOLIC[®]. Oily dirt causes splintering, splitting, or other defects of the paint. It must be completely removed with a soft cloth dipped in alcohol, N-hexane, etc.
- If storing or drying is not proper, the adhesion or other performance may be adversely affected. Therefore, observe the storing condition of each paint as specified by the manufacturer.
- Since storing in high temperature may cause deformation, keeping the storing temperature under 175°F and hold ALPOLIC[®] horizontally.

Masking

ALPOLIC[®] comes with a factory applied protective masking film which should be removed after fabrication.

Storage

ALPOLIC[®] is packed in wooden crates and can usually be stacked up to four crates high.

When storing unpacked ALPOLIC[®] observe the following guidelines:

- To prevent warping or bending, place it horizontally on pallet or other stand.
- Avoid stacking ALPOLIC[®] of different sizes together, as the surface or panel can be scratched by the edges of the smaller pieces.
- Preferably, store them by size in racks.
- In storing them by leaning against the rack as shown below, lay a rubber mat underneath and lean the ALPOLIC[®] closely against the fixed back-up material.

RACKING SYSTEM

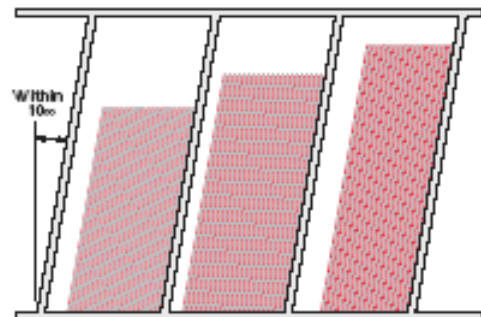

Thermal Expansion/Contraction

Thermal expansion/contraction should always be considered when designing with ALPOLIC®. The expansion/contraction can be determined by the following calculations.

**Thermal Expansion/ Contraction
(inches)=LXC_{th}T(°F)XL(feet)**

C_{th} is coefficient of thermal expansion -
13x10⁻⁶ 1M/1M/°F

L is the length of ALPOLIC®.

$\Delta T = T_a - T_i$

T_a is the actual temperature.

T_i is the temperature when ALPOLIC® was fabricated or installed.

Positive ΔT shows expansion, and negative ΔT contraction.

Thermal Expansion/Contraction Per (INCHES)foot			
ΔT	3mm	4mm	6mm
10	0.0014	0.0016	0.0016
20	0.0029	0.0031	0.0031
30	0.0043	0.0047	0.0047
40	0.0058	0.0062	0.0062
50	0.0072	0.0078	0.0078
60	0.0086	0.0094	0.0094
70	0.0101	0.0109	0.0109
80	0.0115	0.0125	0.0125
90	0.0130	0.0140	0.0140
100	0.0144	0.0156	0.0156
110	0.0158	0.0172	0.0172
120	0.0173	0.0187	0.0187

Cleaning

The following cleaning procedure can be used for all ALPOLIC® finishes, including Megaflon® coatings.

ALPOLIC®'s Lumiflon® resin finish is self-cleaning and should shed airborne dust and dirt in rain showers. If cleaning is required, use the following procedure in order of increasing difficulty of removal.

1. Flush with water from hose.
2. Wipe lightly with a soft cloth.
3. Use pressure washer.
4. Use mild detergent in power wash or with a soft cloth for hand wiping and flush with water.

For stubborn stains, graffiti, etc.:

1. Prepare a mixture of 1 part of Mirachem 500 Liquid, to 3 to 10 parts of water depending on desired strength. Solvents like alcohols are not recommended in view of environmental health and fire safety. Some solvents may also cause gloss change or paint damage.
2. Wash the ALPOLIC surface with the Mirachem 500 water solution by hand using a lamb's wool mitt or soft cloth. Do not rub the surface hard.
3. IMMEDIATELY use a garden hose to rinse the ALPOLIC surface with water.

Note that a power washer (3,000 psi) only removes light dirt and does not remove streaks of grime.

Mirachem 500 liquid is available in 1, 5 and 55 gallons containers. 1 gallon of Mirachem 500 (4-11 gal. mixed) cleans approximately 1,500 - 4,000 ft² of panel surface. For smaller areas, use Mirachem Foaming Aerosol.

Supplier:

The Mirachem Corporation
1045 South Edward Drive
Tempe, AZ 85181

Contact: 800.847.3527 / 602.966.3030

